

SHOREMASTER®

PREMIUM DOCKS, BOAT LIFTS AND ACCESSORIES





RESHAPING YOUR WATERFRONT.
Discover the ShoreMaster difference.



CONTENTS

- 04 Docks/Piers
- 14 QuickConnect®
- 20 Decking Options
- 24 Lifts/Hoists
- 34 Motors
- 36 Canopies
- 40 Accessories
- 42 Specifications



SHOREMASTER



The Infinity Dock System™

INFINITELY CONFIGURABLE. ULTIMATE CUSTOMIZATION.

Take your waterfront experience to the next level with the Infinity Dock System from ShoreMaster. Engineered with **stability** and **durability** in mind the real distinction of the Infinity System comes from its ability to perfectly suit your needs - even as they change. From the **QuickConnect®** assembly and accessory system and industry leading **11 decking options**, all the way down to the geometry of our **5-Sided Dock Leg®** and pocket, the Infinity Dock System was designed with your experience in mind. Whether you are looking for the **ultimate in configurability**, unmatched **strength and stability** or traditional design and **easy installation**, there is an Infinity Dock System to meet your needs.

INFINITY CURVE

THE ULTIMATE IN WATERFRONT ELEGANCE, DISTINCTION, AND FUNCTIONALITY.



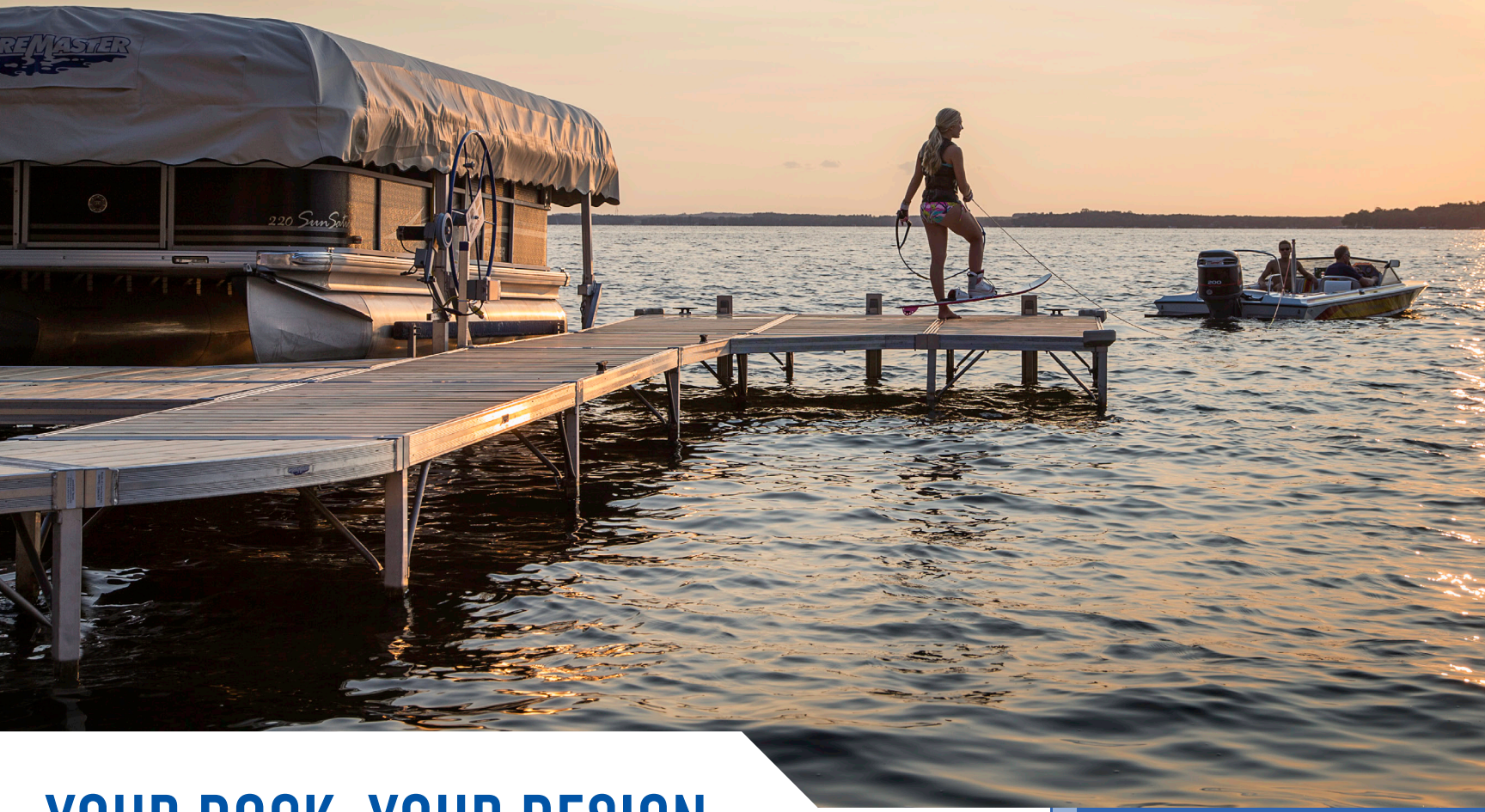

YOUR DOCK. YOUR DESIGN. NO COMPROMISE.

Your shoreline doesn't concede to straight lines and right angles - so why should your dock/pier system. ShoreMaster's exclusive 45° and 90° curve sections provide the versatility, functionality, and elegance your waterfront experience needs and deserves.

Our Infinity curve dock sections offer premium performance and superior curb appeal.

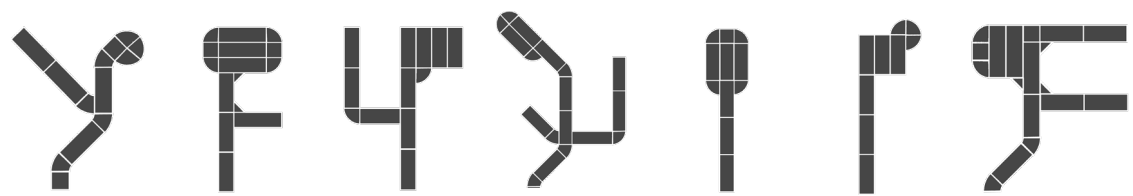
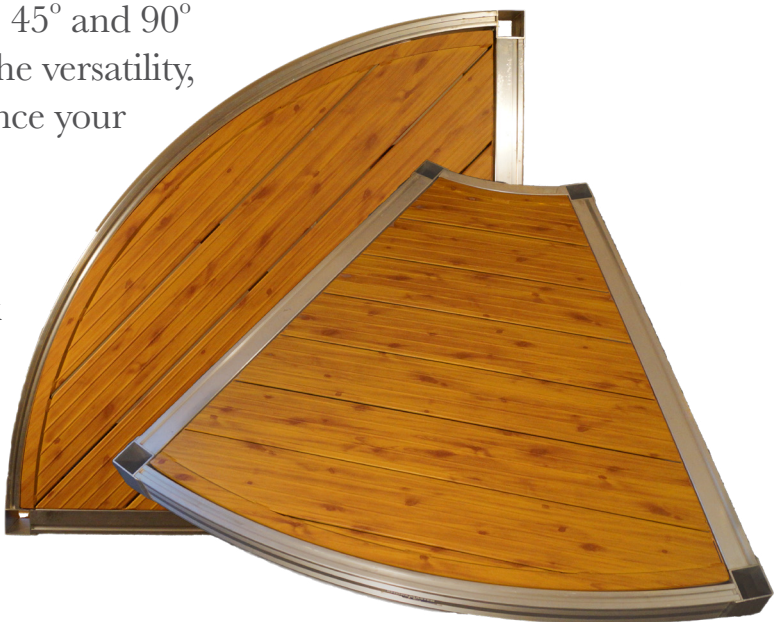

SHOREMASTER EXCLUSIVE

- Unmatched Elegance
- 45° and 90° Curve Sections

SUPERIOR STRENGTH

- Welded Aluminum
- 5-Sided Dock Legs® for 3-points of contact
- 4" Side Rail

THE ULTIMATE IN CONFIGURABILITY

- Maximize your Shoreline
- Endless Configuration Options
- Easy Installation with the QuickConnect System

INFINITY RS4

ULTIMATE CUSTOMIZATION. EASY INSTALLATION. PREMIUM STABILITY.





WELDED ALUMINUM FOR SUPERIOR STRENGTH

- Welded Aluminum Frames
- 4" Side Rail

PREMIUM STABILITY

- 5-Sided Dock Legs® for 3-Points of Contact
- Unmatched Stability and Safety

QUICK, EASY INSTALLATION

- Lightweight Aluminum
- QuickConnect® Installation and Accessory System
- No Drilling, No Hassles

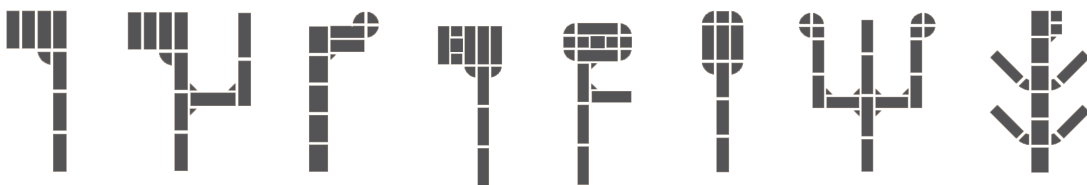

Page 42 for Sizes & Specifications

INFINITY RS7

INDUSTRY LEADING STRENGTH AND STABILITY. UNLIMITED CONFIGURABILITY.





SUPERIOR STRENGTH

- Welded Aluminum Frames
- Industry Leading 7" Rail

HIGH-END ELEGANCE

- 6' Wide Sections Available
- 11 Premium Decking Options

EASY HEIGHT ADJUSTMENTS

- Screw Legs
- Adapt to Fluctuating Water

EASY CUSTOMIZATION

- Lightweight Aluminum
- QuickConnect® Installation and Accessory System
- No Drilling, No Hassles

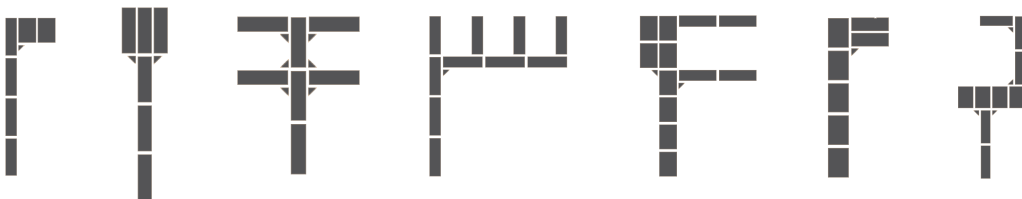

Page 42 for Sizes & Specifications

INFINITY TS9 AND FTS9

CLASSIC TRUSS DESIGN. SUPERIOR STABILITY. HASSLE-FREE OWNERSHIP.





STAND IT. ROLL IT. FLOAT IT.



TIMELESS DESIGN, PREMIUM STRENGTH AND STABILITY

- Classic 9" Truss Side
- Welded Aluminum Frame
- 5-Sided Dock Legs® with 3-Points of Contact
- Premium Flotation System

FLUCTUATING & DEEP WATER SOLUTION

- Available as Standing, Wheel-In or Floating System
- Adapt to Fluctuating Water

QUICK, EASY INSTALLATION

- Lightweight Aluminum
- QuickConnect® Installation and Accessory System
- No Drilling, No Hassles

Page 42 for Sizes & Specifications

ACCESSORIZE YOUR DOCK, YOUR WAY

Hassle-free configurability to fit your needs.





QUICKCONNECT®

THE EASIEST WAY TO CUSTOMIZE YOUR DOCK.

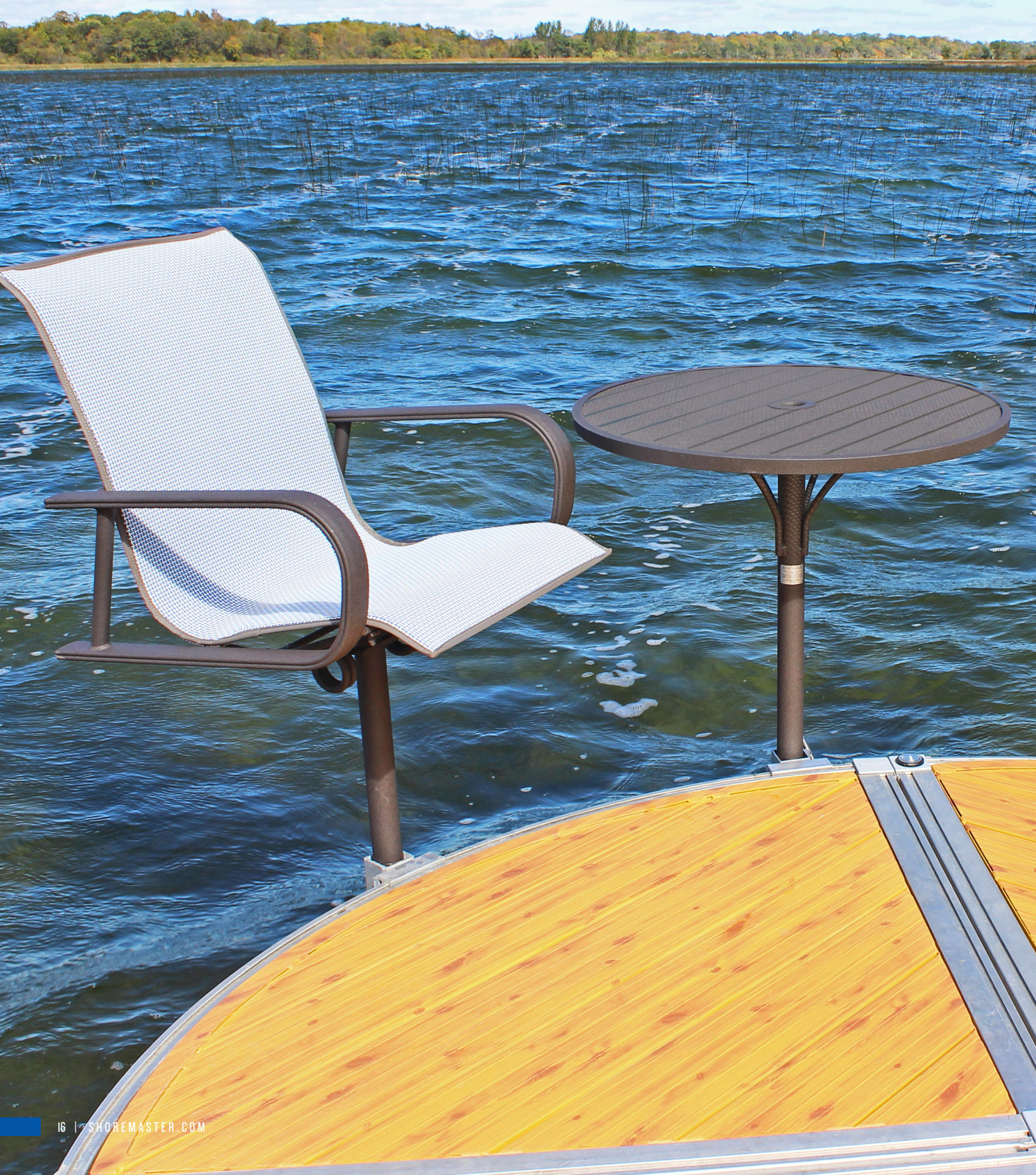

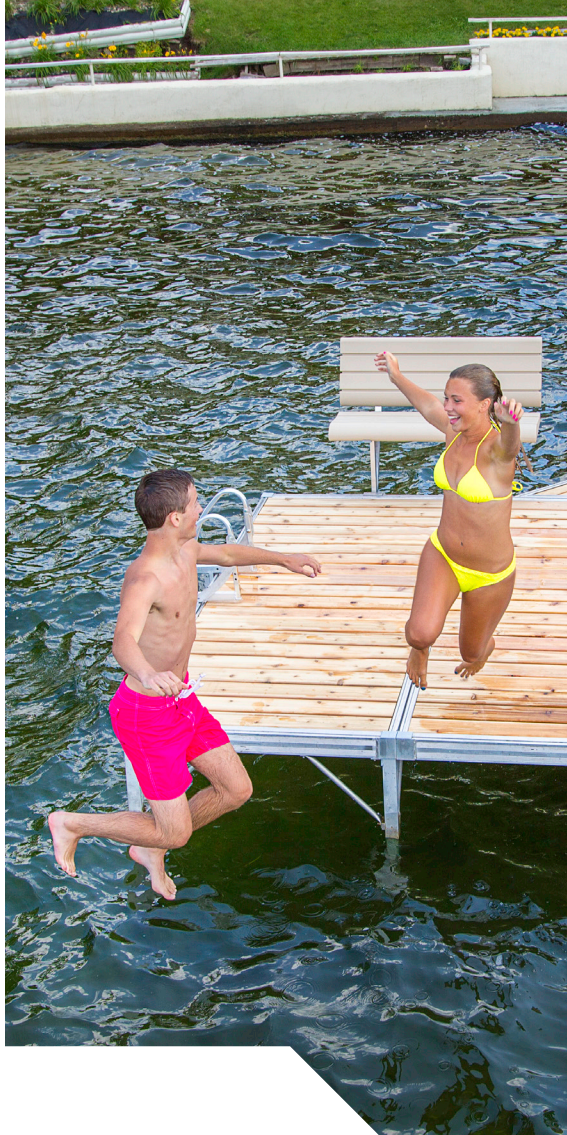

A DOCK SYSTEM THAT EVOLVES WITH YOU. COMPLETE CUSTOMIZATION.

Imagine adding, removing, or reconfiguring your dock accessories at a moment's notice, and without the need for tools. When you choose a ShoreMaster dock system, you'll enjoy the convenience of QuickConnect accessories.

NO DRILLING. NO HOLES.

After the initial setup, you will never need tools to adjust or reconfigure your dock accessories. You won't find an easier system anywhere else.



SHOREMASTER EXCLUSIVE

- T-Handle Installation
- No Drilling. No Holes.

TOOL FREE CONFIGURATION

- Change Your Mind at a Moment's Notice
- Tool Free Reconfiguration
- Easy Installation

THE ULTIMATE IN CONFIGURABILITY

- Endless Configuration Options
- Reconfigure and Upgrade as Your Needs Change

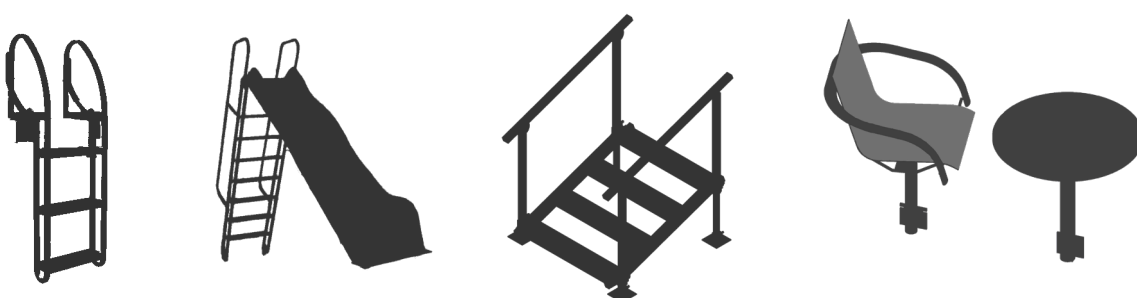



NEW HOMECREST DOCK FURNITURE

CHAIRS, TABLE AND UMBRELLA | QUICKCONNECT

Enjoy your waterfront more from the comfort of your dock system. Our premium furniture and benches are easy to add, remove and adjust for a beautiful look and relaxing atmosphere.

Two styles of furniture available; see dealer for details.

Multiple fabric options available:



NEW SOLAR DOCK LIGHTS

NO CORD OR WIRING | SOLAR POWERED | EASY INSTALL | 5 COLORS AVAILABLE

Set your Infinity Dock System aglow in the evening with solar paneled dock lights from ShoreMaster.

Mounted directly into the dock leg caps our dock lights are easy to install and offer an attractive and unobtrusive low profile – no tripping, no wasted dock space. A bright solar powered LED light provides an evening illumination without the hassle of cords or wires.

Available in White, Blue, Red, Green and Amber



QUICK STEPS

4- AND 6- STEP OPTIONS | PIVOTING ANGLE | TWO STYLES AVAILABLE | QUICKCONNECT

ShoreMaster's NEW Quick Steps feature a wider step, deep tread and can be used as dock steps or landscaping steps for the ultimate waterfront experience. Also available are our standard dock steps.

4- and 6- step options available in both styles.

Quick Steps feature 33.75" stair opening, 41" overall width, and 7.125" stair tread.

See page 40 for additional dock accessories

WATERSPORT RACK

SINGLE AND DOUBLE RACK OPTIONS | QUICKCONNECT

Store your paddleboard, kayak or canoe off of your dock with an accessory bracket that attaches to the outside perimeter of your dock at any location.

Single and double rack options available. Versatile design can accommodate nearly any watersport equipment including paddleboards, kayaks, and canoes.

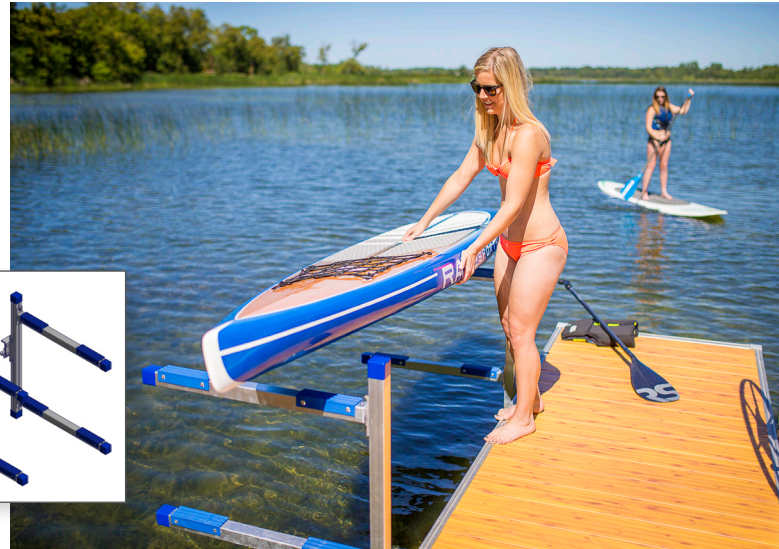
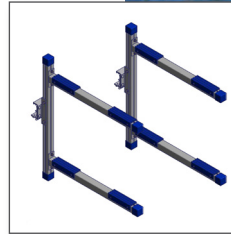

PIVOT LADDER

3-, 4-, AND 5- STEP OPTIONS | QUICKCONNECT

Get in and out of the water easily with ShoreMaster's QC Pivot Ladders. A vertical pivoting action and locking pin allows you to flip the ladder up when you're not using it, making it ideal for swimmers.

3-, 4- and 5- step options available.

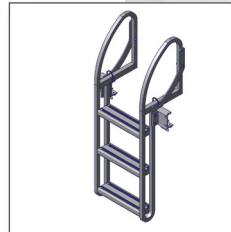

NEW STAND-UP PADDLEBOARD RACK

EASY, SECURE BOARD & PADDLE STORAGE | QUICKCONNECT

Our SUP storage rack is the best way to store your Stand Up Paddleboards dockside so they are ready to ride whenever you are. The SUP Storage Rack is designed to fit any style of stand up paddleboard, and the storage rack arms are vertically adjustable so you can store your SUP at the perfect height for you. With easy installation and seamless protection for our paddleboards we make it even more convenient for you to get out on your next paddling adventure.





SHOREMASTER

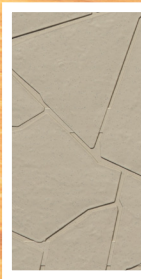
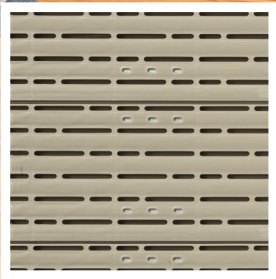
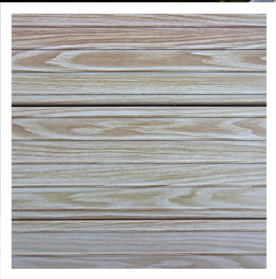
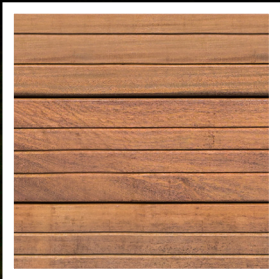



Choose from the industry's
MOST DECKING OPTIONS.

ShoreMaster dock systems feature removable decking panels, but why?

There are a number of reasons. First, we build the strength of our dock systems into the frame sections themselves. We don't rely on the decking attachment to provide the system its strength. Second, it's better for the owners of our systems. It provides you options and makes installation, removal, upkeep and upgrades so much easier.

Why choose a removable deck panel system?

- Panels can be removed for installation/removal, making sections lighter and easier to carry and install
- Opportunity to update or upgrade the look of your system without replacing frame sections
- Easily replace individual panels if necessary - no need to replace an entire dock section
- Trust that the integrity and strength of your system is built into the frame itself



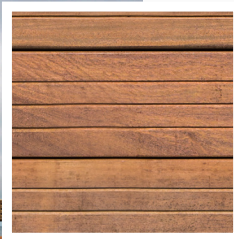

HARDWOOD IPE

LUXURIOUS | DURABLE | NATURAL | LOW-MAINTENANCE

You want real wood decking with low maintenance requirements. IPE hardwood decking from ShoreMaster adds stability to your dock system because its density adds additional weight to the overall dock system. IPE decking feels firm and stable under foot and its natural oils resist warping, insects and decay to provide you with a natural wood decking option that's remarkably low maintenance.

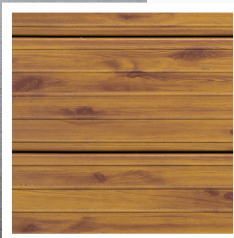
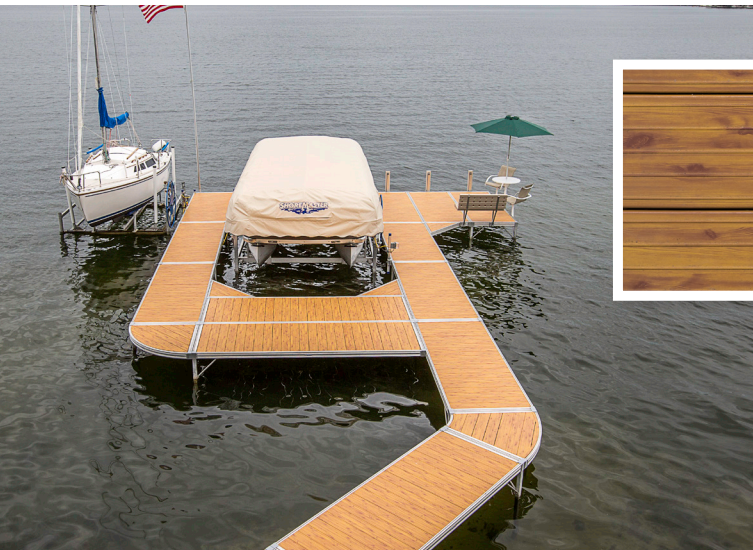

TRADITIONAL WOODGRAIN ALUMINUM

MAINTENANCE-FREE | POWDER-COATED | DURABLE

You want all of the natural beauty of real wood decking, but you need it to be maintenance free. Woodgrain aluminum decking gives you just that. Woodgrain powder-coated aluminum decking won't rot, twist, warp or decay, so your dock will look like new year after year. Get all of the benefits of natural wood, without the hassle of annual wood decking maintenance.



GRAY OAK WOODGRAIN ALUMINUM

MAINTENANCE-FREE | POWDER-COATED | DURABLE

Add timeless beauty and durability to your dock system with our Gray Oak woodgrain aluminum decking. Utilizing an Italian process paint application, our woodgrain decking features a non-repeating pattern so you get the uniqueness and natural appearance of wood without all the maintenance and hassle. Plus, the treaded surface provides you with a safe, cool to the touch decking option that's as comfortable as it is beautiful.

VERTEX® (GRAY AND TAN)

SHOREMASTER EXCLUSIVE | MAINTENANCE-FREE | SLIP-RESISTANT

If you want a maintenance-free decking option that is truly unique. You want the ShoreMaster exclusive Vertex decking. With a flagstone pattern, Vertex feels smooth on bare feet, looks great, and is incredibly slip resistant. Once you've walked on Vertex decking, you won't want anything else for your family.



FLOW THROUGH (GRAY AND TAN)

LIGHT-WEIGHT | MAINTENANCE-FREE | SLIP-RESISTANT

Flow Through decking is one of the easiest decking options to own because the open concept of the design will not collect dirt and debris. This allows it to dry faster and stay clean longer. You'll be able to enjoy a great looking dock system without any of the decking maintenance and cleaning. Flow Through decking is easy on your feet, and its slip-resistant surface allows you to safely, and comfortably enjoy time spent on your dock.



PAINTED ALUMINUM (TAN AND WHITE)

POWDER-COATED | MAINTENANCE-FREE | DURABLE | STAYS COOL

ShoreMaster's painted aluminum decking is among our most popular aluminum decking options as it provides a safe, comfortable decking surface. Powder-coated in natural tan or white, you get an attractive decking option to complement your waterfront property. Painted aluminum decking features a treaded surface and stays cool to the touch, so your family can truly enjoy every summer day on your dock.





SHOREMASTER

220 SunSaver



Precision welded lifts provide

MAXIMUM DEPENDABILITY

You can rely on a **precision, welded aluminum boat lift** from ShoreMaster to improve your boating experience by providing you with maximum **stability**, superior **durability**, and the ultimate in **reliability** and **performance**.

Our lifts are an **easy-to-use** and **dependable** way to access and store your boat. When you choose the **safety, dependability, and simplicity** of a ShoreMaster boat lift, you'll spend more time boating with your friends and family, and less time performing maintenance and making adjustments to your lift. ShoreMaster lifts can be configured to fit any style of boat, so no matter how you boat, you'll enjoy it more with a ShoreMaster boat lift.

HYDRAULIC LIFT

EXPERIENCE PREMIUM WITH OUR FASTEST LIFT AND HIGHEST CAPACITIES.





FAST, EASY OPERATION

- Our Fastest Lift Model
- Convenient Remote Control Operation Comes Standard

HIGHEST CAPACITIES

- Up to 12,500 lbs
- Can Accommodate Nearly Any Style of Watercraft

ULTIMATE DURABILITY

- Welded Aluminum Frame
- Premium Hydraulic Pump
- Simple, Reliable Operation

MINIMAL MAINTENANCE

- Traditional Hydraulic Design
- No Cables Means Less Maintenance

Page 43 for Sizes & Specifications

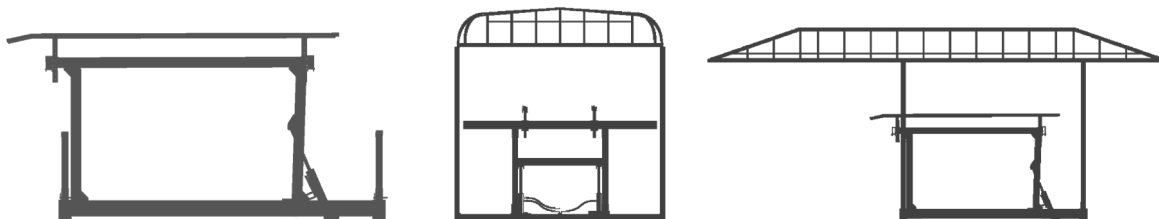

VERTICAL LIFT

DURABILITY. VERSATILITY. TIMELESS DESIGN.



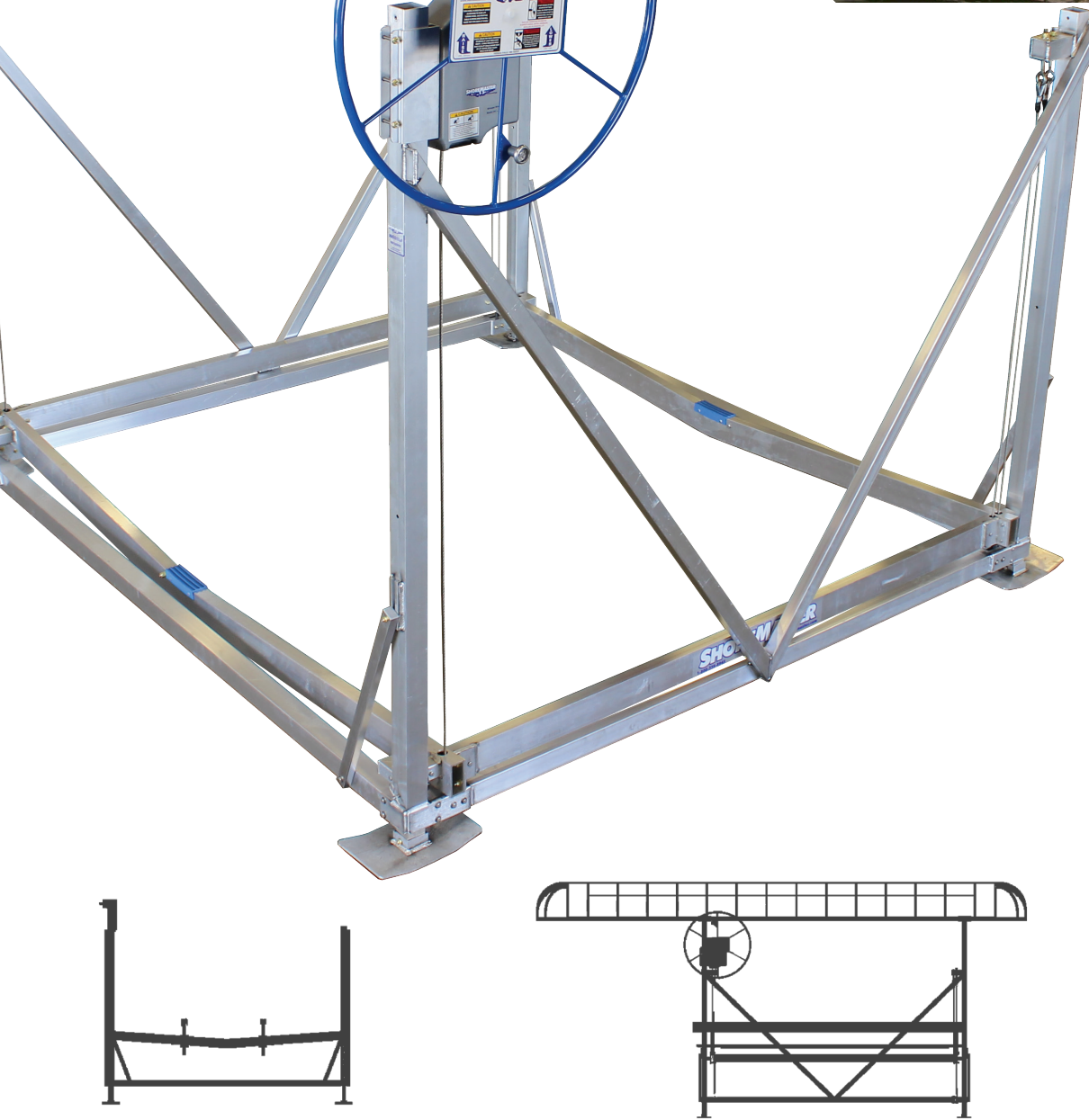

TIME-TESTED DESIGN

- Manufacturers of the First Welded Aluminum Vertical Boat Lift
- Time-Tested Design
- Expertly Manufactured
- Double V-Side
- Whisper Winch® System

SUPERIOR STABILITY

- Welded Aluminum Frame
- Corner Bracing

SHALLOW WATER SOLUTION

- V-Rack Design
- 66" Lift Rack Travel
- Premium Low and Fluctuating Water Solution

Page 43 for Sizes & Specifications

PONTOON LIFT

PERFORMANCE AND STABILITY DESIGNED FOR TODAY'S PONTOONS.



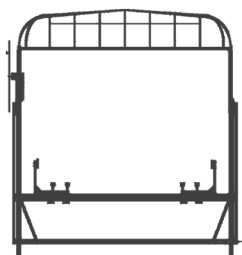
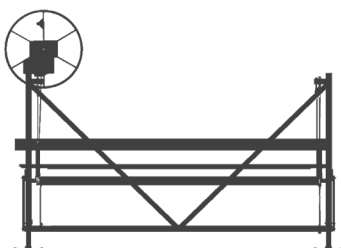
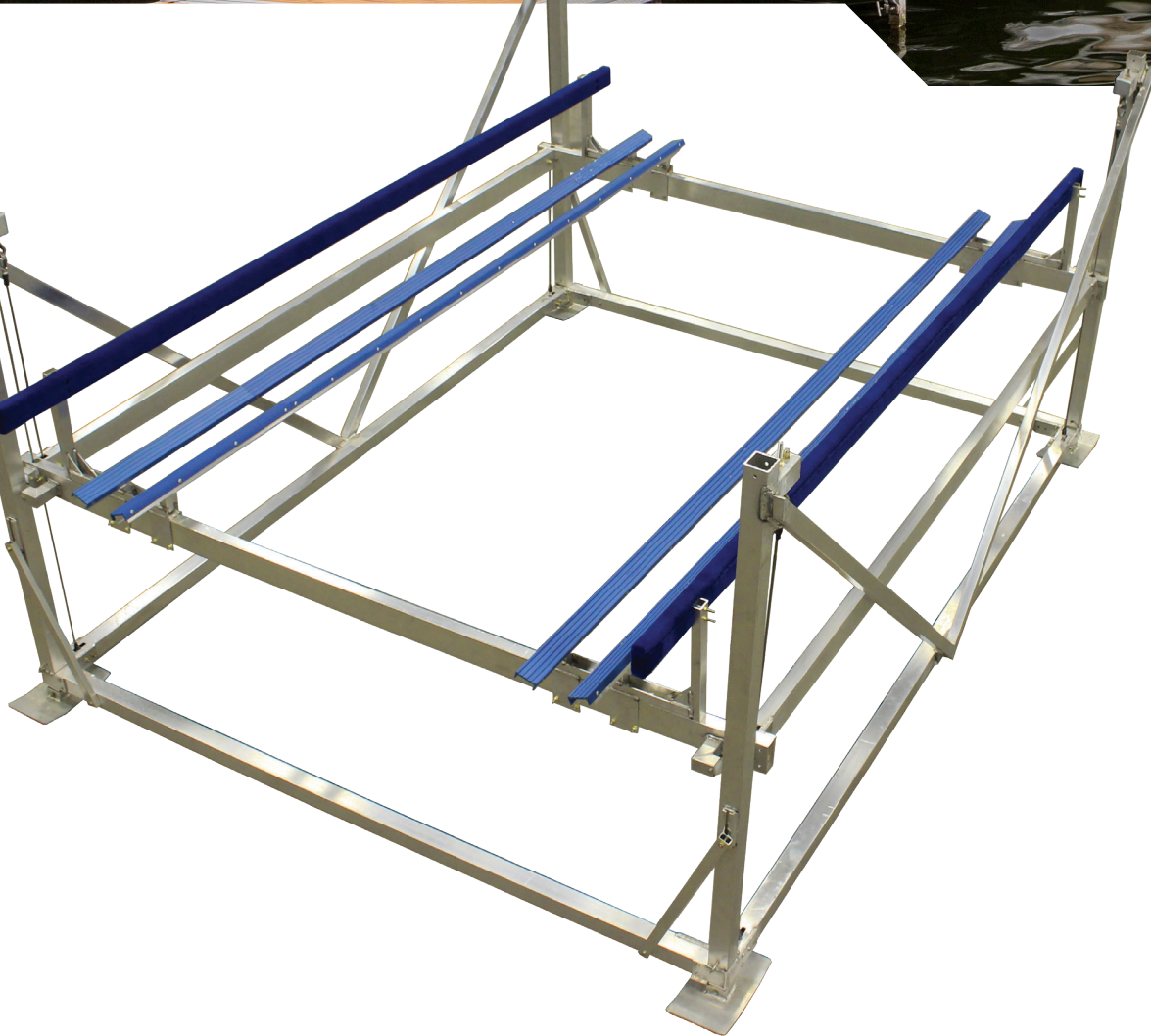

*Tri-Toon Cradles
Available; Sold
Separately. See Dealer
for Details.*

OVER-SIZED FOR TODAY'S PONTOONS

- Wider, Longer Frame for Larger Pontoons
- Ideal for Pontoons Longer than 26'
- Guide Rail System for Even Weight Distribution

EASY OPERATION

- Lift Boss or Lift Mate Motor
- Remote Operation

PREMIUM PERFORMANCE

- Welded Aluminum Frame
- Whisper Winch® System

Page 43 for Sizes & Specifications

SHOREPORT®

EASY ON. EASY OFF. ALWAYS READY.



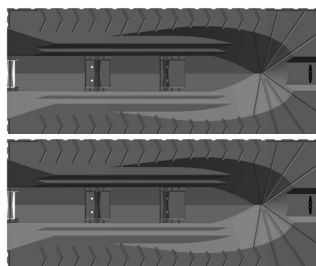
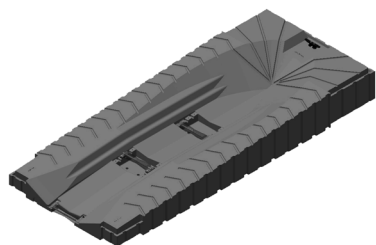

SAFE & RELIABLE

- Slip-Resistant Surface
- Side Walking Platform

SUPERIOR STABILITY

- Bottom Cavities Increase Stability & Weight Capacity

EXTENDED STORAGE

- 8" Cleat
- Secure, Out-of-Water Extended Storage

EASY LOADING AND UNLOADING

- Three Adjustable Polyurethane Rollers
- Accommodates Nearly Any Personal Watercraft

MOTORS & CANOPIES

MAXIMUM CONVENIENCE. SUPERIOR PROTECTION. ULTIMATE DURABILITY.



ShoreMaster
OUT

1. Understand all warnings and warnings prior to use.
2. Never use the motor for anything other than its intended purpose.
3. Always use the correct fuel mixture and oil ratio.
4. Always use the correct fuel mixture and oil ratio.
5. Always use the correct fuel mixture and oil ratio.
6. Always use the correct fuel mixture and oil ratio.
7. Always use the correct fuel mixture and oil ratio.
8. Always use the correct fuel mixture and oil ratio.
9. Always use the correct fuel mixture and oil ratio.
10. Always use the correct fuel mixture and oil ratio.

CAUTION: This unit must be operated in a properly rated
transom. Do not exceed the maximum weight of the boat or use the
motor in excess of the capacity of the boat and motor. Do not
exceed the maximum weight of the boat and motor. Do not
exceed the maximum weight of the boat and motor. Do not
exceed the maximum weight of the boat and motor.

www.shoremaster.com
800-855-8585
1-800-855-8585
ShoreMaster

Member of the
Johnson Outboard

Lift Capacity
3000 lbs.
CAUTION
STOP
HERE

LIFT BOSS™

DEPENDABLE | QUIET OPERATION | EASY TO INSTALL

Add enjoyment to your time spent on the water with ShoreMaster's Lift Boss Boat Lift Motor. The Lift Boss is the quickest and easiest way to upgrade your ShoreMaster boat lift to add the convenience of motorized boat lift operation.

The Lift Boss is incredibly easy to install, easy to use and it's designed to perform flawlessly season after season.



AVAILABLE ACCESSORIES:

- Wireless Remote
- Corded Remote
- Solar Panel
- Battery Tray
- Canopy Light
- Extensions/Jumper Wires
- and more!

PREMIUM PERFORMANCE

- No More Hand Cranking
- More Time on the Water
- Reliable performance
- Solar power option

EASY OPERATION

- Standard Key-Turn Operation
- Available Wireless Remote or Corded Remote

20-MINUTE INSTALLATION

- Quick, Easy Installation
- Mounting Kit for ShoreMaster Whisper Winch® Included

POWER OPTIONS



110V



12/24V

LIFT MATE™

EASY INSTALLATION | SIMPLE TO USE | UNIVERSAL DESIGN

You want a boat lift motor that is easy to install, easy to operate, and won't let you down when it's time to take your boat for a cruise or when you return from time spent on the water.

The Lift Mate provides you with all of that with a universal design perfect for new or existing boat lifts.

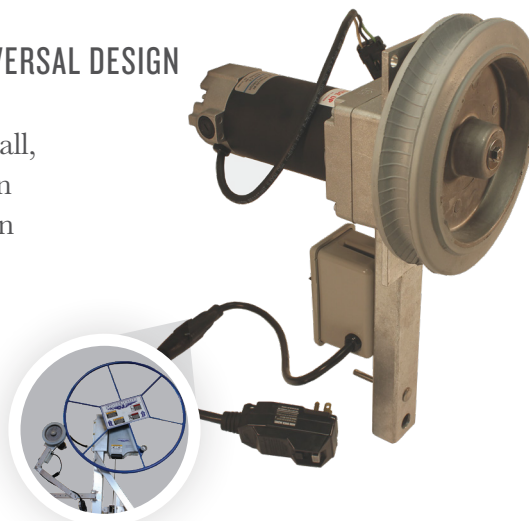

EASY INSTALLATION

- Installs with Simple Hand Tools
- Quick Lift Upgrade

POWER OPTIONS



110V



12V

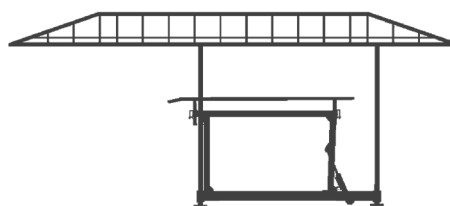
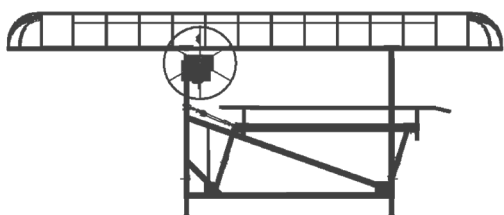
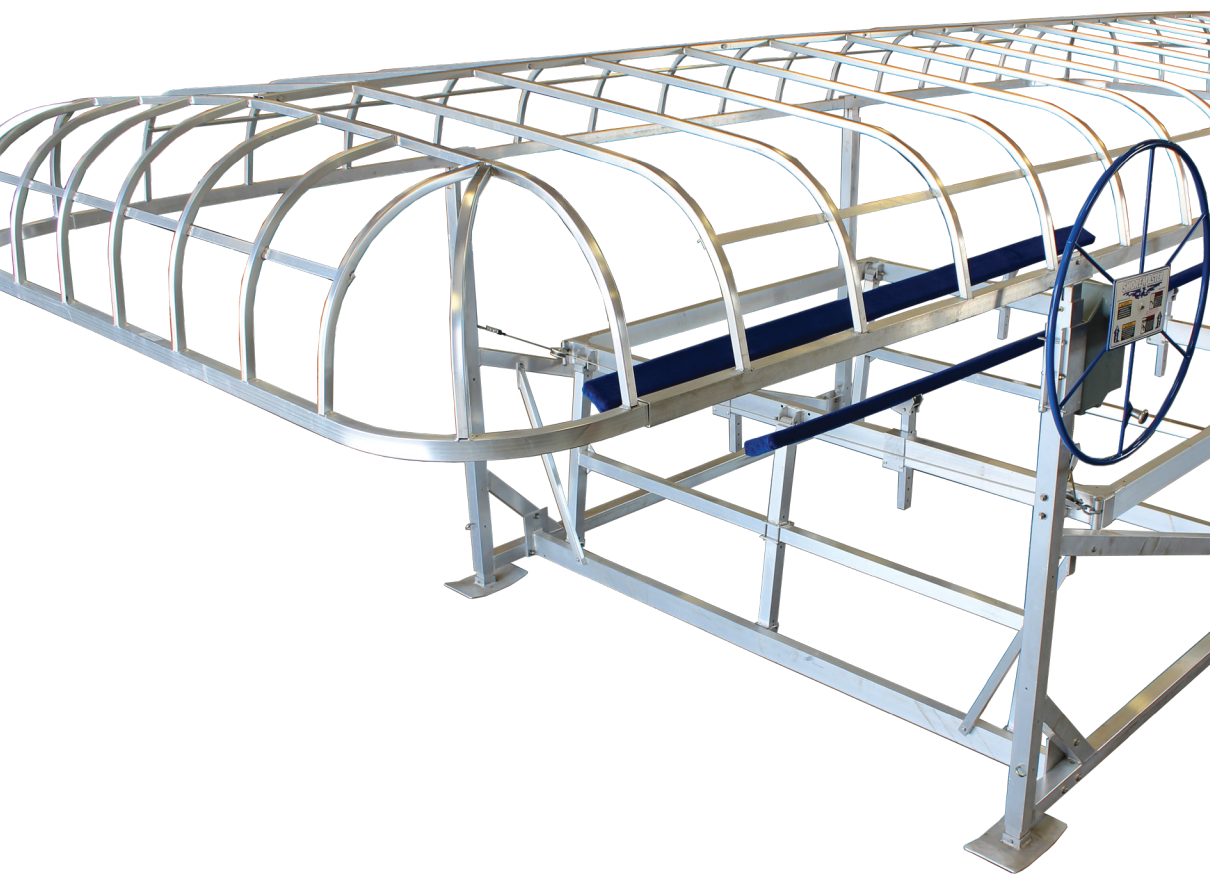

PROTECT YOUR INVESTMENT

- Maintain Boat Value with Protection from Elements
- Vented Ends for Breathability, Inhibits Mold and Mildew

SUPERIOR COVERAGE

- Deep, Rounded Design
- Shallow Pitch
- Tuck Boat Completely Underneath Frame

EASY ASSEMBLY AND INSTALLATION

- Welded Aluminum Frame
- Less Pieces and Time than Bolt-Together Systems

HIP ROOF AVAILABLE

- Hip Roof Frame also available

BEST

WEATHERMAX®

LIGHT-WEIGHT | PROTECTION | COLOR RETENTION | EASY INSTALLATION

ShoreMaster's WeatherMax® fabric canopy covers offer superior protection from the elements for your boat. You'll enjoy WeatherMax's ease-of-use when it comes to installation, removal or storage of the cover because WeatherMax is incredibly lightweight and easy to handle.

WeatherMax canopy covers from ShoreMaster have a reputation for long-lasting color retention, incredible durability and superior protection from the elements.

- Features a water-repellent HydroMax™ finish for long-lasting protection, durability, and color retention
- Lightweight engineered yarn fabric provides a soft feel, vibrant colors, and easy installation and removal

COLOR OPTIONS*



BURGUNDY



PACIFIC BLUE

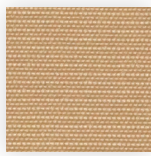

SANDSTONE

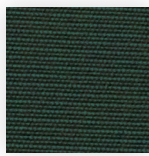

FOREST GREEN

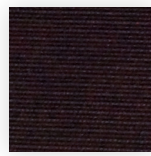

BLACK

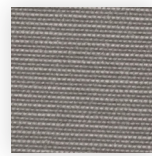

LIGHT CHARCOAL

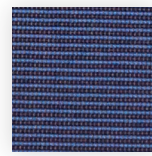

SAPPHIRE TWEED

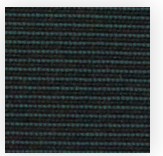

FOREST TWEED

BETTER

13oz VINYL WITH TOP COAT

DURABLE | LIGHT-WEIGHT | PROTECTION | EASY INSTALLATION

The addition of an OEM exclusive top coat to our 13oz vinyl canopy cover provides superior durability and performance. The 13oz vinyl canopy cover with top coat will outperform heavier 18oz vinyls in the following areas: tear resistance, grab tensile, strip tensile and hydrostatic resistance.

- Top coat finish provides you with superior durability, clean-ability, complete protection from the elements, and unmatched weatherproofing
- Additional boat coverage is provided by the deep scalloping around the perimeter of the canopy cover

GOOD

13oz VINYL

DURABLE | LIGHT-WEIGHT | PROTECTION | EASY INSTALLATION

13oz vinyl canopy cover is designed to be very lightweight without sacrificing the durability or moisture and UV protection that you expect from a premium vinyl canopy cover.

- 13oz vinyl material is incredibly lightweight, so installation and removal is quicker, easier and less cumbersome
- Additional boat coverage is provided by the deep scalloping around the perimeter of the canopy cover

COLOR OPTIONS*

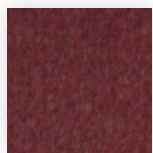

BURGUNDY

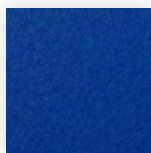

BLUE

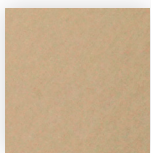

TAN

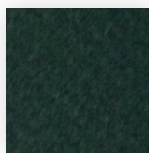

FOREST

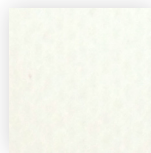

WHITE

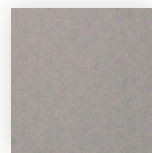

GRAY



TRUST YOURSELF. CHOOSE SHOREMASTER.

Docks, lifts, & accessories for your life and your style.

You know exactly what your waterfront experience looks like. You can imagine exactly how your summertime adventures will play out. You know exactly what you need to make your ideas a reality.

Take the next step, trust yourself, choose ShoreMaster. You'll find yourself amazed by the professional, friendly service you'll receive from ShoreMaster's industry-leading nationwide dealer network. When you visit an authorized ShoreMaster dealer, you'll get to experience ShoreMaster quality and premium design first-hand as you walk on a ShoreMaster Infinity dock or operate a ShoreMaster boat lift. You'll find your ideas coming to life when you choose ShoreMaster.

DOCK/PIER ACCESSORIES

Make Your Dock & Lift System Work For You.

QUICKCONNECT® DOCK ACCESSORIES

See pages 14-19 for additional information and accessories



DOCK STEPS
*4- and 6- Step
Options*

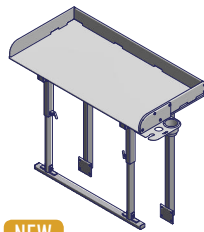

NEW
**FISH CLEANING
TABLE**

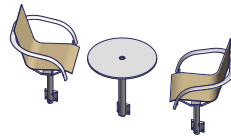

DOCK FURNITURE
*2 Chairs, Table &
Umbrella*



DOCK BENCH
*Available with or
without armrests*

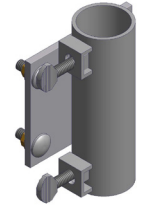

**FLAGPOLE OR
UMBRELLA HOLDER**



HANDRAIL
*Various Lengths
Available*



**FISHING ROD
HOLDER**



**BOAT LIFT
HANDRAIL**



DOCK BUMPERS
*Vertical, Horizontal,
and Corner Options*

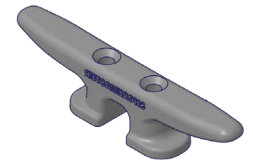

CLEATS



**TELESCOPING
FLAGPOLE W/
FLAG**



**SHORE-END
WHEEL-IN KIT**



**WINCH LEVELING
KIT**

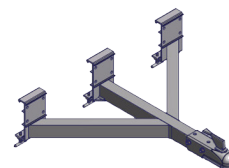

QC TOW HITCH
*For Infinity RS7 &
Infinity TS9 systems only*



SCREW LEGS
*For use with wheel
or foot pads*

RAMPS AND GANGWAYS

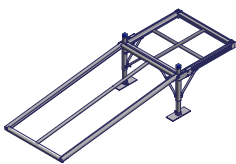

RAMPS
*4' x 4', 4' x 8' and
6' x 8' Frames*

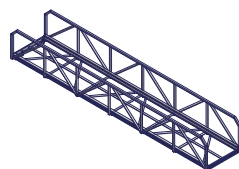

GANGWAYS

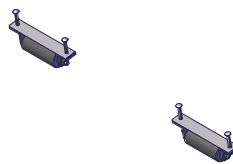

ROLLER KIT

**LEARN MORE ABOUT
SHOREMASTER ACCESSORIES
BY VISITING YOUR LOCAL DEALER
OR SHOREMASTER.COM**

LIFT/HOIST ACCESSORIES

Make Your Dock & Lift System Work For You.

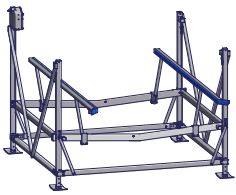

FULL LENGTH GUIDES

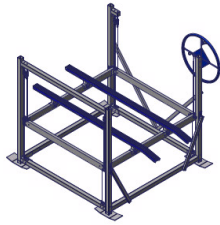

BUNKS

Carpeted or Vinyl Options Available

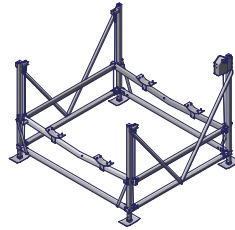

CRADLES

V-Hull, Pontoon, & Tri-Toon Options

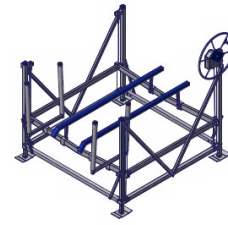

PVC GUIDES

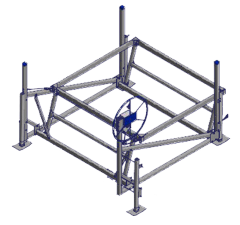

SCREW LEGS



POLY TIRES

For both docks and lifts

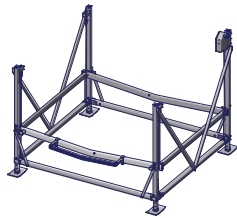

MOTOR STOP



UNI-CADDY



WHEEL CADDY

Tri- and Quad-Caddy Options

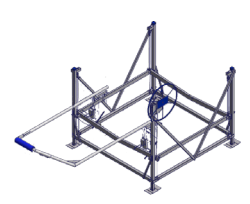

BOW GUIDE

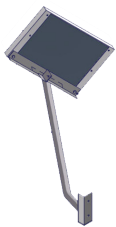

SOLAR PANEL

12V and 24V Options

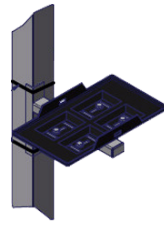

BATTERY TRAY

Leg & Canopy Mount Options

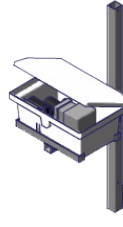

HYDRAULIC BOX HOLDER



LIFT ASSIST TOOL

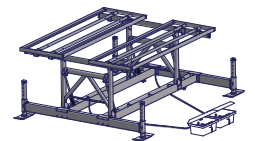

FLOAT PLANE PLATFORM

PONTOON ACCESSORIES

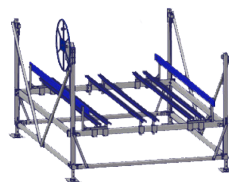

TRI-TOON CRADLE

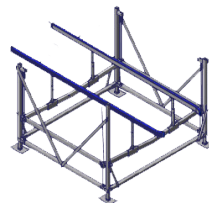

PONTOON RAIL KIT

Wood Required; Sold Separately

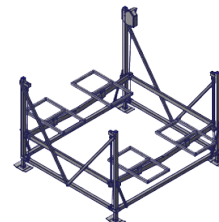

PONTOON RACKS

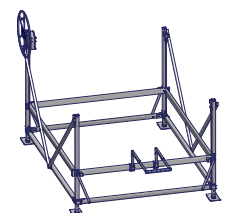

PONTOON MOTOR STOP

SPECIFICATIONS

CHOOSING THE RIGHT PRODUCT HAS NEVER BEEN SO EASY.

INFINITY RS4 <i>p. 6-9</i>		SIZE	WEIGHT*	QUICKCONNECT® DOCK ACCESSORIES <i>see page 14 for more information</i>																																			
		4' x 4'	52 lbs	5-SIDE DOCK LEGS™ & POCKET	CLEATS	DOCK LEG CAPS	GANGWAYS	HINGES	INFINITY CATERPILLAR CLIP	L-ADAPTERS	L-BRACES	POLY TIRES	OC BOAT LIFT HANDRAIL	OC CANOE/KAYAK RACK	OC DOCK BENCH	OC DOCK BUMPERS	OC DOCK FURNITURE (2 STYLES) NEW STYLE	OC DOCK STEPS & QUICK STEPS (2 STYLES)	OC FISH CLEANING TABLE NEW	OC FISHING POLE HOLDER	OC FLAGPOLE HOLDER	OC HANDRAIL	OC PIVOT LADDER	OC PIPE BRACKETS	OC RAMP	OC DUAL STAND-UP PADDLEBOARD (SUP) RACK NEW	OC TOW HITCH	OC UMBRELLA HOLDER	RAMP ROLLER KIT	SCREW LEGS	SHORE-END WHEEL KIT	SOLAR DOCK LIGHTS NEW	TELESCOPING FLAG POLE	WHEEL-AXEL ADAPTER	WINCH LEVELING KIT				
		4' x 10'	82 lbs																																				
		4' x 12'	97 lbs																																				
		6' x 8'	90 lbs																																				
		3' Corner	20 lbs																																				
		45°	33 lbs																																				
		90°	36 lbs																																				
INFINITY RS4 ACCESSORIES AVAILABLE																																							
INFINITY RS7 <i>p. 10-11</i>		4' x 8'	80 lbs	5-SIDE DOCK LEGS™ & POCKETS	CLEATS	DOCK LEG CAPS	GANGWAYS	HINGES	INFINITY CATERPILLAR CLIP	L-ADAPTERS	L-BRACES	POLY TIRES	OC BOAT LIFT HANDRAIL	OC CANOE/KAYAK RACK	OC DOCK BENCH	OC DOCK BUMPERS	OC DOCK FURNITURE	OC DOCK STEPS	OC FISH CLEANING TABLE	OC FISHING POLE HOLDER	OC FLAGPOLE HOLDER	OC HANDRAIL	OC PIVOT LADDER	OC PIPE BRACKETS	OC RAMP	OC DUAL STAND-UP PADDLEBOARD (SUP) RACK	OC TOW HITCH	OC UMBRELLA HOLDER	RAMP ROLLER KIT	SCREW LEGS	SHORE-END WHEEL KIT	SOLAR DOCK LIGHTS	TELESCOPING FLAG POLE	WHEEL-AXEL ADAPTER	WINCH LEVELING KIT				
		4' x 16'	131 lbs																																				
		6' x 8'	97 lbs																																				
		6' x 16'	155 lbs																																				
		3' Corner	28 lbs																																				
INFINITY RS7 ACCESSORIES AVAILABLE																																							
INFINITY TS9 <i>p. 12-13</i>		4' x 8'	61 lbs	5-SIDE DOCK LEGS™ & POCKETS	CLEATS	DOCK LEG CAPS	GANGWAYS	HINGES	INFINITY CATERPILLAR CLIP	L-ADAPTERS	L-BRACES	POLY TIRES	OC BOAT LIFT HANDRAIL	OC CANOE/KAYAK RACK	OC DOCK BENCH	OC DOCK BUMPERS	OC DOCK FURNITURE	OC DOCK STEPS	OC FISH CLEANING TABLE	OC FISHING POLE HOLDER	OC FLAGPOLE HOLDER	OC HANDRAIL	OC PIVOT LADDER	OC PIPE BRACKETS	OC RAMP	OC DUAL STAND-UP PADDLEBOARD (SUP) RACK	OC TOW HITCH	OC UMBRELLA HOLDER	RAMP ROLLER KIT	SCREW LEGS	SHORE-END WHEEL KIT	SOLAR DOCK LIGHTS	TELESCOPING FLAG POLE	WHEEL-AXEL ADAPTER	WINCH LEVELING KIT				
		4' x 16'	102 lbs																																				
		6' x 8'	77 lbs																																				
		6' x 16'	125 lbs																																				
		3' Corner	19 lbs																																				
INFINITY TS9 ACCESSORIES AVAILABLE																																							
FLOATING FTS9 <i>www.shoremaster.com</i>		2' x 4'	21 lbs	5-SIDE DOCK LEGS™ & POCKETS	CLEATS	DOCK LEG CAPS	GANGWAYS	HINGES	INFINITY CATERPILLAR CLIP	L-ADAPTERS	L-BRACES	POLY TIRES	OC BOAT LIFT HANDRAIL	OC CANOE/KAYAK RACK	OC DOCK BENCH	OC DOCK BUMPERS	OC DOCK FURNITURE	OC DOCK STEPS	OC FISH CLEANING TABLE	OC FISHING POLE HOLDER	OC FLAGPOLE HOLDER	OC HANDRAIL	OC PIVOT LADDER	OC PIPE BRACKETS	OC RAMP	OC DUAL STAND-UP PADDLEBOARD (SUP) RACK	OC TOW HITCH	OC UMBRELLA HOLDER	RAMP ROLLER KIT	SCREW LEGS	SHORE-END WHEEL KIT	SOLAR DOCK LIGHTS	TELESCOPING FLAG POLE	WHEEL-AXEL ADAPTER	WINCH LEVELING KIT				
		4' x 4'	30 lbs																																				
		4' x 8'	61 lbs																																				
		4' x 16'	102 lbs																																				
		6' x 8'	62 lbs																																				
		6' x 16'	122 lbs																																				
		3' Corner	19 lbs																																				
FLOATING FTS9 ACCESSORIES AVAILABLE																																							

MODEL	CAPACITY	Inside Width	Lift Travel/Height	Std. Leg Length	Overall Width	Overall Length	Winch Model	Canopy Length		
NEW 1264 SR-PWC	1,200 lbs	64"	50"	24"	72"	80"	DL 1202	13'	*	Refer to 1200PWC for available accessories
1296	1,200 lbs	96"	50"	24"		80"	DL 1202	31'	*	Refer to 1200PWC for available accessories + 8' Horizontal Bunks Available (for use with sailboats)
2208 SR	2,200 lbs	96"	66"	36"	108"	127"	141 Whisper	21'		
3009 DVS	3,000 lbs	108"	66"	36"	120"	127"	141 Whisper	21'-27'		
3010 DVS	3,000 lbs	120"	66"	36"	132"	127"	141 Whisper	23'-33'		
4009 DVS	4,000 lbs	108"	66"	36"	120"	127"	241 Whisper	21'-27'		
4010 DVS	4,000 lbs	120"	66"	36"	132"	127"	241 Whisper	23'-33'		
5010 DVS	5,000 lbs	120"	66"	36"	132"	127"	241 Whisper	23'-33'		
6010 DVS	6,000 lbs	120"	66"	36"	132"	127"	241 Whisper	23'-33'	BATTERY TRAY	
LIFT ACCESSORIES AVAILABLE										•
701068 SR	7,000 lbs	120"	66"	36"	132"	166"	SM 7000	23'-33'		
LIFT ACCESSORIES AVAILABLE										•
4010 PTN	4,000 lbs	120"	66"	36"	132"	175"	241 Whisper	23'-33'		
5510 PTN	5,500 lbs	120"	66"	36"	132"	175"	241 Whisper	23'-33'		
701168 PTN	7,000 lbs	132"	68"	36"	144"	238"	SM 7000	27'-35'	BATTERY TRAY	
* Comes standard with Pontoon Rail Guide System										
LIFT ACCESSORIES AVAILABLE										•
1200 PWC	1,200 lbs	64"	28"	24"	72"	77"	DL 1202	13'		
LIFT ACCESSORIES AVAILABLE										•
40108	4,000 lbs	108"	40"	36"	120"	139"	141 Whisper	23'-27'		
40120	4,000 lbs	120"	40"	36"	132"	139"	141 Whisper	23'-33'	BATTERY TRAY	
50120	5,000 lbs	120"	40"	36"	132"	139"	241 Whisper	23'-33'	BOW GUIDE	
LIFT ACCESSORIES AVAILABLE										•
40948	4,000 lbs	108"	48"	36"	120"	138"		21'-29'		
40960	4,000 lbs	108"	60"	36"	120"	138"		21'-29'		
401048	4,000 lbs	120"	48"	36"	132"	138"		23'-33'		
401060	4,000 lbs	120"	60"	36"	132"	138"		23'-33'		
60948	6,000 lbs	108"	48"	36"	120"	138"		21'-29'		
601060	6,000 lbs	120"	60"	36"	132"	138"		23'-33'		
801148	8,000 lbs	132"	48"	36"	144"	186"		27'-35'		
801160	8,000 lbs	132"	60"	36"	144"	186"		27'-35'	BATTERY TRAY	
LIFT ACCESSORIES AVAILABLE										•
101148	10,000 lbs	132"	48"	36"	149"	205"		27'-35'		
101160	10,000 lbs	132"	60"	36"	149"	205"		27'-35'		
121160	12,000 lbs	132"	60"	36"	149"	243"		27'-35'		
LIFT ACCESSORIES AVAILABLE										•

	10' x 55"	10' x 10"	13' x 64"	19' x 84"	21' x 96"	21' x 108"	23' x 100"	23' x 108"	23' x 120"	25' x 108"	25' x 120"	25' x 132"	27' x 108"	27' x 120"	27' x 132"	29' x 108"	29' x 120"	29' x 132"	31' x 120"	31' x 132"	33' x 120"	33' x 132"	35' x 132"	24' x 108"	24' x 120"	26' x 108"	26' x 120"	28' x 108"	28' x 120"
Traditional Canopy Frame Sizes	•	•	•	•	•	•	•	•	•	•	•	•	•	•	•	•	•	•	•	•	•	•	•	•	•	•	•	•	•
Hip-Roof Canopy Frame Sizes																									•	•	•	•	•
13oz Vinyl with Top Coat Canopy Cover Sizes	•	•	•	•	•	•	•	•	•	•	•	•	•	•	•	•	•	•	•	•	•	•	•	•	•	•	•	•	•
WeatherMax® Canopy Cover Sizes	•	•	•	•	•	•	•	•	•	•	•	•	•	•	•	•	•	•	•	•	•	•	•	•	•	•	•	•	•

SHOREMASTER®

A stylized white splash graphic that appears to be dripping or splashing downwards from the bottom of the 'SHOREMASTER' text. The splash is composed of several irregular, rounded shapes that merge together, creating a sense of movement and liquid.

COVERING THE WATERFRONT SINCE 1972